



Product categories



Meat



Chicken



Delicatessen

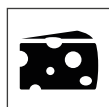

Cheese



Dairy products



Gastronomy

Technical features



Ventilated

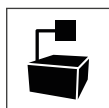

Remote
condensing unit



Electric defrost



Off-cycle
defrost

Certification and patents



Epta Adamant



Epta
FoodDefence

Product range

DUO					
Length -Lunghezza Longueur-Länge-Longitud mm	1250	1875	2500	3750	EOL2000
LL-225	•	•	•	•	•
MAX LL-365	•	•	•	•	•
Display area Superficie di esposizione Warenpräsentationsfläche Surface d'exposition Superficie expositiva m2	2.03	3.03	4.05	6.06	1.46
Loading area Superficie di appoggio Nutzfläche Surface de chargement Superficie de apoyo m2	2.50	3.74	5.03	7.55	2.27
End thickness Spessore spalla Stärke der Seitenwand Épaisseur de chaque joue Espesor lateral mm	50.00				

Cross sections

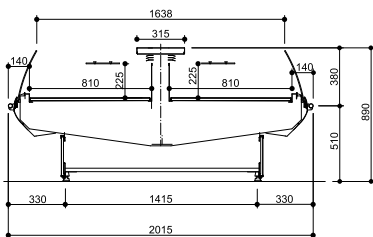

CLOSED BASE - LL 225

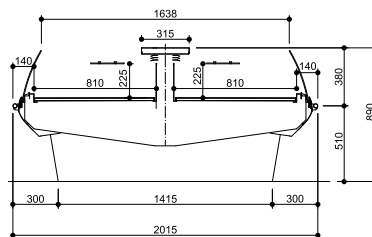

COVERED LEGS - LL 225

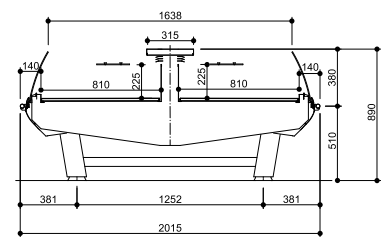

ELLIPTICAL LEGS - LL 225

Cross Sections

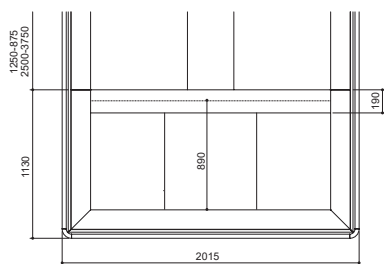

EOL - LL 225

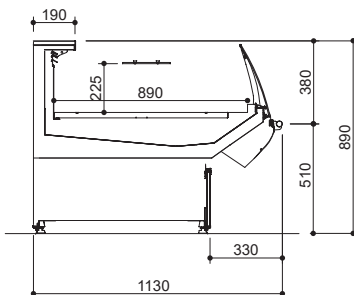

EOL - LL 225

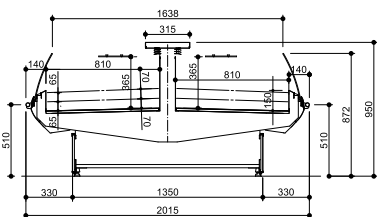

CLOSED BASE - MAX LL 365

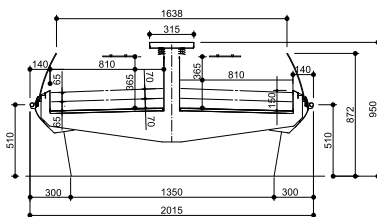

COVERED LEGS - MAX LL 365

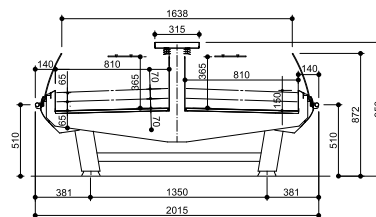

ELLIPTICAL LEGS - MAX LL 365

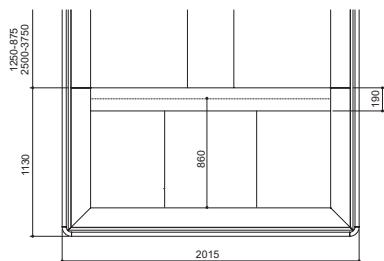

EOL - MAX LL 365

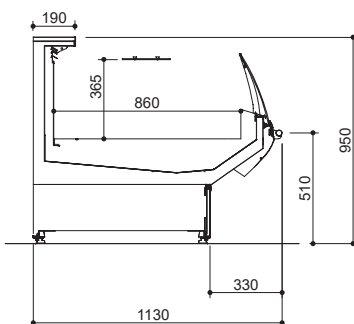

EOL - MAX LL 365